



DATA SHEET

AGC 150

Engine drive



1. AGC 150 engine drive

1.1 About.....	3
1.2 Application diagram.....	3
1.3 Software packages.....	3
1.4 Functions and features.....	4
1.4.1 Display, buttons and LEDs.....	4
1.4.2 Engine functions.....	5
1.4.3 General functions.....	6
1.4.4 Protections.....	6
1.4.5 Supported controllers and engines.....	7
1.4.6 Exhaust after-treatment (Tier 4/Stage V).....	10
1.4.7 Typical wiring for engine drive controller.....	11

2. Compatible products

2.1 Remote display: AGC 150.....	13
2.2 Additional operator panel, AOP-2.....	13
2.3 Additional inputs and outputs.....	13

3. Technical specifications

3.1 Electrical specifications.....	14
3.2 Environmental specifications.....	16
3.3 UL/cUL Listed.....	17
3.4 Communication.....	17
3.5 Approvals.....	18
3.6 Dimensions and weight.....	18

4. Legal information

4.1 Disclaimer.....	19
4.2 Copyright.....	19
4.3 Software version.....	19

1. AGC 150 engine drive

1.1 About

The AGC 150 engine drive is a single controller for one engine. The controller has all the functions needed to protect and control an engine. The values and alarms are shown on the LCD display screen, which is sunlight-readable.

The controller is simple to mount and the graphical display unit makes it easy to use. The parameters can easily be configured on the display unit or with the use of a PC and the utility software.

Key features

- Protect and monitor the engine
- Engine start and stop sequences
- Automatic and manual control of engine speed
- Tier 4F/Stage V
- Configurable inputs and outputs, including
 - CAN bus ports
 - Ethernet port
- Alarm and event log
- 3-level password protection
- Easy configuration with the utility software
- Pump function with fixed and variable speed

1.2 Application diagram

Engine controller

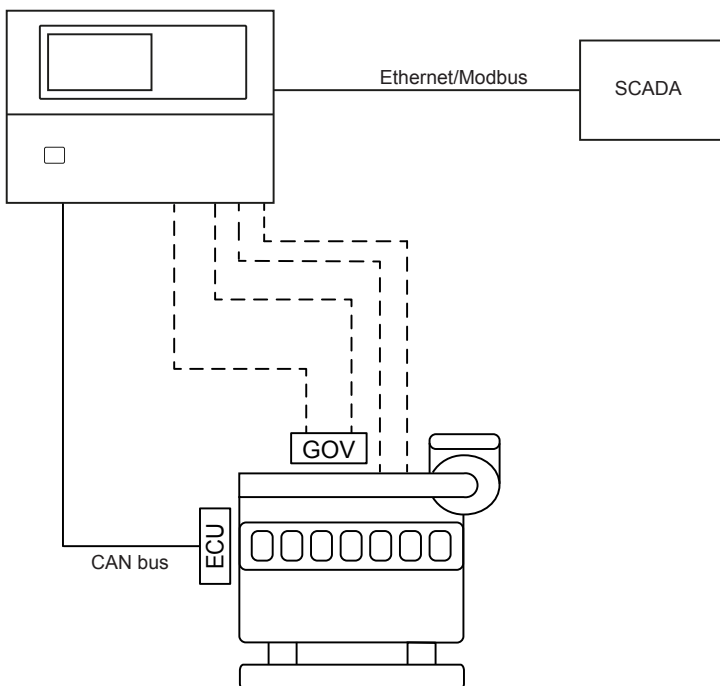

1.3 Software packages

Software package	Application type
Stand-alone	Any engine-driven application

Alternatively, you can use an extended or premium software package. You can then also change to another AGC 150 controller type.

1.4 Functions and features

1.4.1 Display, buttons and LEDs

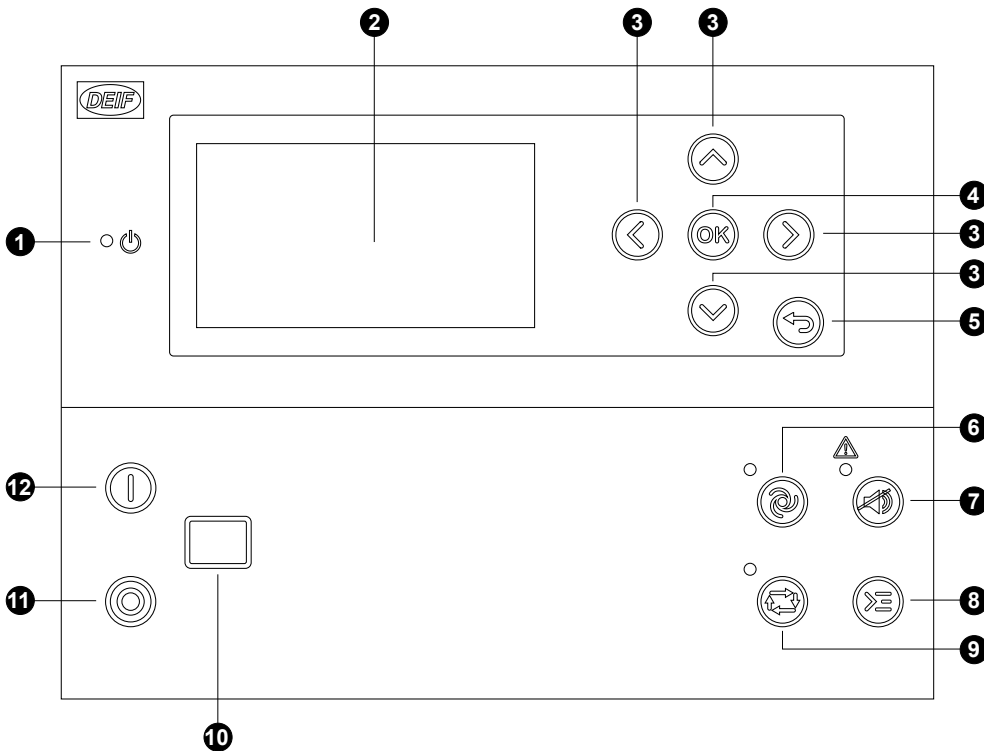

No.	Name	Function
1	Power	Green: The controller power is ON. OFF: The controller power is OFF.
2	Display screen	Resolution: 240 x 128 px. Viewing area: 88.50 x 51.40 mm. Six lines, each with 25 characters.
3	Navigation	Move the selector up, down, left and right on the screen.
4	OK	Go to the menu system. Confirm the selection on the screen.
5	Back	Go to the previous page.
6	AUTO mode	The controller automatically starts and stops the engine. No operator actions are needed.
7	Silence horn	Stops an alarm horn (if configured) and enters the alarm menu.
8	Shortcut menu	Access jump to parameter, running mode, test and lamp test.
9	SEMI-AUTO mode	The controller cannot automatically start and stop the engine. The operator can start and stop the engine manually from the display.
10	Engine	Green: There is running feedback or an external signal. Green flashing: The engine is getting ready. Red: The engine is not running, or there is no running feedback.
11	Stop	Stops the engine if SEMI-AUTO or manual mode is selected.
12	Start	Starts the engine if SEMI-AUTO or manual is selected.

1.4.2 Engine functions

Start and stop functions

Engine start and stop sequence

Temperature-dependent cooling down

Time-based cooling down

Configurable crank and run coil

Built-in test sequence (simple test)

Regulation functions

Governor regulation using:

- Engine communication
- Built-in analogue control
- External analogue control using IOM 230
- Relays

Manual speed control using:

- Digital inputs
- Display screen menu (by the operator)
- Analogue input
- Modbus
- Configured set point

Speed sensing using CAN or MPU

Derate engine

Fixed speed or variable regulation speed

Ramp function for loading and de-loading

Ventilation fan control

Other engine functions

Fuel usage monitoring

Fuel pump logic and refill

Diesel exhaust fluid monitoring

Diesel exhaust fluid logic and refill

Generic fluid monitoring

Generic fluid logic and refill

Counters

Start attempts

Running hours

Service intervals

Fan

1.4.3 General functions

Setting and parameter functions
Nominal settings
User-defined permission levels
Password-protected setup
Trending with the USW
Event logs with password, up to 500 entries

Display and language functions
Supports multiple languages (including Chinese, Russian, and other languages with special characters)
20 configurable display screens
Graphical display with six lines
Parameters can be changed on the display unit
3 engine function shortcuts
20 configurable shortcut buttons
5 configurable display screen "LED lamps" (on/off/blink)

Modbus functions
Modbus RS-485
Modbus TCP/IP
Configurable Modbus area

PID functions
PIDs for controlling user-defined set points
Reference value for PIDs with analogue inputs
2 x general purpose PID regulators (built-in analogue outputs)

Logic and output functions
PLC logic (M-Logic)
4 analogue outputs (using 2 x IOM 230)

1.4.4 Protections

Protections	ANSI
Overspeed	12
Crank failure	48
Running feedback error	34
MPU wire break	-
Start failure	48
Stop failure	48
Stop coil, wire break alarm	5

Protections	ANSI
Emergency stop	1
Engine heater	26
Max. ventilation/radiator fan	-
Not in remote mode	34
Fuel fill check	-
Low auxiliary supply	27DC
High auxiliary supply	59DC
Maintenance alarms	-

1.4.5 Supported controllers and engines

The AGC can communicate with the following ECUs and engines.

Manufacturer	ECU	Engines	Tier 4/Stage V	AGC parameter 7561
Generic J1939	Any ECU that uses J1939	Any engine that uses J1939	●	Generic J1939
Baudouin	WOODWARD PG+	-	-	Baudouin Gas
Baudouin	Wise 10B	-	-	Baudouin Wise10B
Baudouin	Wise 15	-	●	Baudouin Wise15
Bosch	EDC17			Bosch EDC17CV54TMTL
Caterpillar	ADEM3	C4.4, C6.6, C9, C15, C18, C32, 3500, 3600	-	Caterpillar ADEM3
Caterpillar	ADEM4		-	Caterpillar ADEM4
Caterpillar	ADEM3, ADEM4	C4.4, C6.6, C9, C15, C18, C32, 3500, 3600	-	Caterpillar Generic*
Cummins	CM 500	QSL, QSB5, QSX15 and 7, QSM11, QSK 19/23/50/60	-	Cummins CM500
Cummins	CM 558	QSL, QSB5, QSX15 and 7, QSM11, QSK 19/23/50/60	-	Cummins CM558
Cummins	CM 570	QSL, QSB5, QSX15 and 7, QSM11, QSK 19/23/50/60	-	Cummins CM570
Cummins	CM 850	QSL, QSB5, QSX15 and 7, QSM11, QSK 19/23/50/60	-	Cummins CM850
Cummins	CM 2150	QSL, QSB5, QSX15 and 7, QSM11, QSK 19/23/50/60	●	Cummins CM2150
Cummins	CM 2250	QSL, QSB5, QSX15 and 7, QSM11, QSK 19/23/50/60	●	Cummins CM2250
Cummins	CM 500, CM 558, CM 570, CM 850, CM 2150 and CM 2250	-	ECU-dependent	Cummins Generic*
Cummins	CM 2350		●	Cummins CM2350
Cummins	CM 2850		●	Cummins CM2850
Cummins	CM 2880		●	Cummins CM2880
Cummins	-	KTA19	-	Cummins KTA19

Manufacturer	ECU	Engines	Tier 4/Stage V	AGC parameter 7561
Detroit Diesel	DDEC III	Series 50, 60 and 2000	-	DDEC III
Detroit Diesel	DDEC IV	Series 50, 60 and 2000	-	DDEC IV
Detroit Diesel	DDEC III, DDEC IV	Series 50, 60 and 2000	-	DDEC Generic*
Deutz	EMR2	-	-	Deutz EMR 2
Deutz	EMR3	-	-	Deutz EMR 3
Deutz	EMR 2, EMR 3	-	-	Deutz EMR Generic*
Deutz	EMR4	-	-	Deutz EMR 4
Deutz	EMR5	-	-	Deutz EMR 5
Deutz	EMR4/EMR5 Stage V	-	●	Deutz EMR 5 Stage V
Doosan	EDC17	-	-	Doosan G2 EDC17
Doosan	MD1	-	●	Doosan MD1
Doosan			●	Doosan stage V
FPT industrial	EDC17	-	-	FPT EDC17CV41
FPT industrial	Bosch MD1	-	●	FPT stage V
Hatz Diesel	-	3/4H50 TICD	●	Hatz
Hatz Diesel	EDC17	-	-	Hatz EDC17
Isuzu	ECM	4JJ1X, 4JJ1T, 6WG1X FT-4	-	Isuzu
Iveco	CURSOR	-	-	Iveco CURSOR
Iveco	EDC7 (Bosch MS6.2),	-	-	Iveco EDC7
Iveco	NEF	-	-	Iveco NEF
Iveco	VECTOR 8	-	-	Iveco Vector8
Iveco	CURSOR, NEF, EDC7, VECTOR 8		●**	Iveco Generic*
Iveco	Bosch MD1	-	●	Iveco Stage V
JCB	-	ECOMAX DCM3.3+	●	JCB
Jichai	JC15D-ECU22	-	-	JC15D Weifu***
Jichai	JC15D WYS		-	JC15D WYS
Jichai	JC190		-	JC190
Jichai	JC15T JG		-	Jichai JC15T JG
John Deere	JDEC	PowerTech M, E and Plus	●	John Deere
John Deere	FOCUS controls (version 2.1)	-	●	John Deere Stage V
Kohler	ECU2-HD	KD62V12	●	Kohler KD62V12
Kubota	KORD3		●	Kubota Stage V
MAN	EDC17	-		MAN EDC17
MAN	EMC 2.0	-	-	MAN EMC Step 2.0
MAN	EMC 2.5	-	-	MAN EMC Step 2.5
MAN	EMC 2.0 and 2.5	-	-	MAN Generic*
MTU	MDEC, module M.201	-		MDEC 2000/4000 M.201
MTU	MDEC module M.302	Series 2000 and 4000	-	MDEC 2000/4000 M.302

Manufacturer	ECU	Engines	Tier 4/Stage V	AGC parameter 7561
MTU	MDEC module M.303	Series 2000 and 4000	-	MDEC 2000/4000 M.303
MTU	MDEC, module M.304	-	-	MDEC 2000/4000 M.304
MTU	ADEC	Series 2000 and 4000 (ECU7), MTU PX	-	MTU ADEC
MTU	ADEC, ECU7 without SAM module (software module 501)	Series 2000 and 4000	-	MTU ADEC module 501
MTU	ECU7 with SAM module	-	-	MTU ECU7 with SAM
MTU	ECU8	-	-	MTU ECU8
MTU	ECU9	-	●	MTU ECU9
MTU	J1939 Smart Connect, ECU8, ECU9	Series 1600	● (ECU9 or later)	MTU J1939 Smart Connect
Perkins	ADEM3	-	-	Perkins ADEM3
Perkins	ADEM4	-	-	Perkins ADEM4
Perkins	ADEM3 and ADEM4	Series 850, 1100, 1200, 1300, 2300, 2500 and 2800	-	Perkins Generic*
Perkins	EDC17	-	-	Perkins EDC17C49
Perkins	-	Series 400 and 1200	●	Perkins Stage V
Perkins	-	Series 400 Model IQ IR IW IY IF	●	Perkins StV 400
Perkins	-	Series 1200F Model MT, MU, MV, MW, BM and BN	●	Perkins StV 1200
Perkins	-	Series 1200J Model SU, VM	●	Perkins StV 120xJ (SU/VM)
PSI/Power Solutions	-	PSI/Power Solutions	●	PSI/Power Solutions
QiYao			-	QiYao Gas
Scania	EMS	-	-	Scania EMS
Scania	EMS S6 (KWP2000)	Dx9x, Dx12x, Dx16x	-	Scania EMS 2 S6
Scania	EMS 2 S8	DC9, DC13, DC16	●	Scania EMS 2 S8
Steyr	EDC17	-	-	Steyr EDC17
Volvo Penta	EDC3	-	-	Volvo Penta EDC3
Volvo Penta	EDC4	-	-	Volvo Penta EDC4
Volvo Penta	EDC III, EDC IV	TAD4x, TAD5x, TAD6x, TAD7x	-	Volvo Penta Generic*
Volvo Penta	EMS, EMS 2.0 to EMS2.3	D6, D7, D9, D12, D16 (GE and AUX variants only)	●	Volvo Penta EMS2
Volvo Penta	EMS2.3		●	Volvo Penta EMS2.3
Volvo Penta	EMS2.4	-	●	Volvo Penta EMS 2.4
Weichai	WOODWARD PG+	Diesel	●	Weichai Diesel
Weichai	WOODWARD PG+	Gas	●	Weichai Gas
Weichai	Wise 10B	-	●	Weichai Wise10B
Weichai	Wise 15	-	●	Weichai Wise15
Weichai			-	Weichai Baudouin E6 Gas

Manufacturer	ECU	Engines	Tier 4/Stage V	AGC parameter 7561
Xichai				Xichai Gas
YANMAR	EDC17	-	-	YANMAR EDC17
Yuchai United	YCGCU (Version 4.2)	Diesel	●	Yuchai United Diesel
Yuchai United	YCGCU (Version 4.2)	Gas	●	Yuchai United Gas
Yuchai United	YC-BCR	-	-	Yuchai YC-BCR
Yuchai United	YC-ECU	-	-	Yuchai YC-ECU

NOTE * Generic protocols are included for backward compatibility.

NOTE ** If supported by the ECU and engine.

NOTE *** Previously *Jichai*

Other EIC protocols: Contact DEIF.







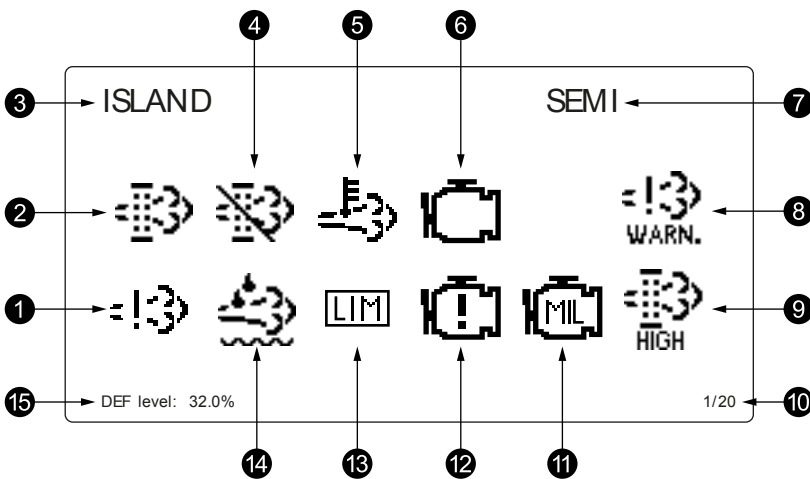



1.4.6 Exhaust after-treatment (Tier 4/Stage V)

AGC 150 supports Tier 4 (Final)/Stage V requirements. It provides monitoring and control of the exhaust after-treatment system, as required by the standard.

AGC 150 Tier 4/Stage V screen



No.	Referent	Symbol	Description
1.	Engine emission system failure		Shows an emission failure or malfunction.
2.	Diesel Particle Filter (DPF)		Shows that a regeneration is needed.
3.	Application mode	-	-
4.	Diesel Particle Filter (DPF) Inhibit		Shows that regeneration is inhibited.
5.	High temperature - Regeneration		Shows a high temperature and regeneration is in process.
6.	Engine interface status		Shows an engine warning.
7.	Operation mode	-	-

No.	Referent	Symbol	Description
8.	Engine emission system failure level	 LOW  HIGH  WARN.	Shows the severity of an emission failure or malfunction.
9.	Diesel Particle Filter (DPF) level	 HIGH  V.HIGH  CRITICAL	Shows the severity of a needed regeneration.
10.	Page number	-	Shows the number of the View menu screen.
11.	Engine interface status		Shows a malfunction.
12.	Engine interface status		Shows an engine shutdown.
13.	LIMIT lamp		Only for MTU engines.
14.	Diesel Exhaust Fluid (DEF)		Shows the fluid tank level is low.
15.	Diesel Exhaust Fluid (DEF) % level	-	Shows the level (%) of the Diesel Exhaust Fluid.

NOTE Grey symbols show that communication is available for the referent. An engine type might not support all of the referents.

1.4.7 Typical wiring for engine drive controller

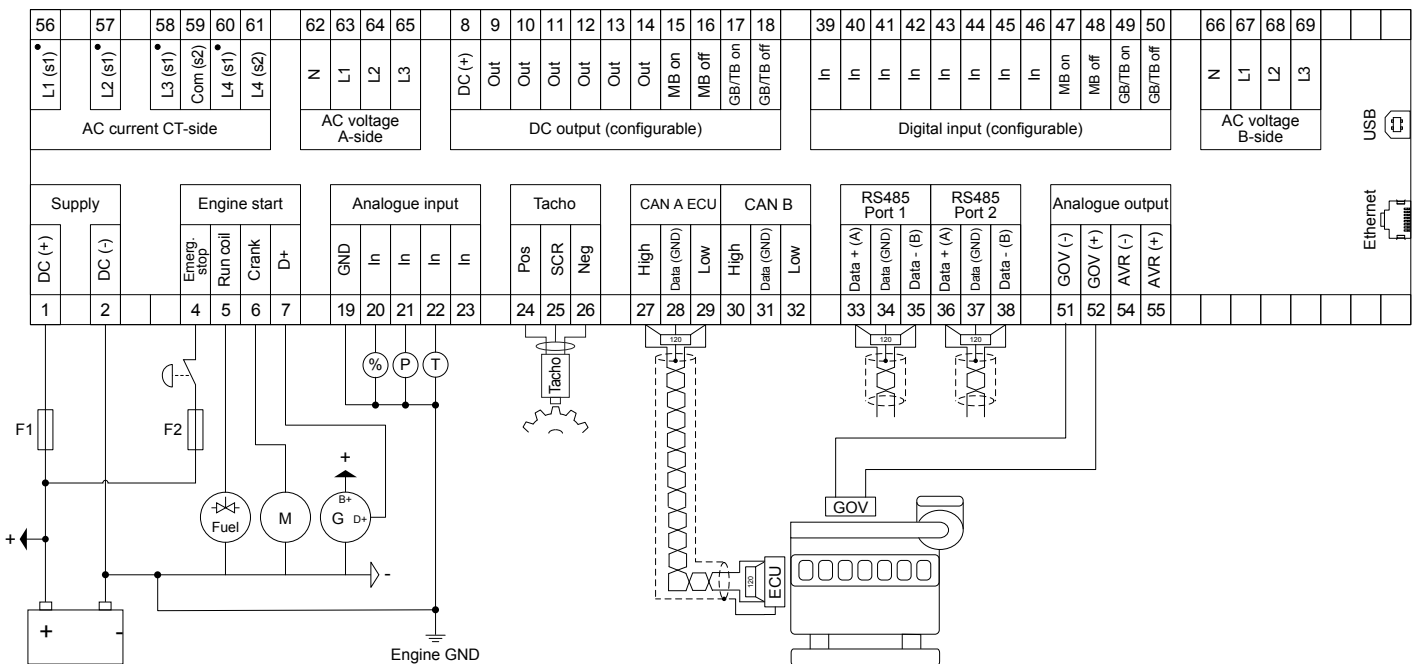

Fuses

- F1: 2 A DC max. time-delay fuse/MCB, c-curve
- F2: 6 A AC max. time-delay fuse/MCB, c-curve

2. Compatible products

2.1 Remote display: AGC 150

The remote display is an AGC 150 that only has a power supply and an Ethernet connection to an AGC 150 controller. The remote display allows the operator to see the controller's operating data, as well as operate the controller remotely.

See www.deif.com/products/agc-150-remote-display

2.2 Additional operator panel, AOP-2

The controller uses CAN bus communication to the additional operator panel (AOP-2). Configure the controller using M-Logic. On the AOP-2, the operator can then:

- Use the buttons to send commands to the controller.
- See LEDs light up to show statuses and/or alarms.

You can configure and connect two AOP-2s if the controller has the premium software package.

2.3 Additional inputs and outputs

AGC 150 uses CAN bus communication with these:

- **CIO 116** is a remote input expansion module. See www.deif.com/products/cio-116
- **CIO 208** is a remote output expansion module. See www.deif.com/products/cio-208
- **CIO 308** is a remote I/O module. See www.deif.com/products/cio-308
- **IOM 220** and **IOM 230** each have two analogue outputs. These can be used for governor and AVR regulation, or general PID control.

3. Technical specifications

3.1 Electrical specifications

Power supply

Power supply range	Nominal voltage: 12 V DC or 24 V DC Operating range: 6.5 to 36 V DC
Voltage withstand	Reverse polarity
Power supply drop-out immunity	0 V DC for 50 ms (coming from min. 6 V DC)
Power supply load dump protection	Load dump protected according to ISO16750-2 test A
Power consumption	5 W typical 12 W max.
RTC clock	Time and date backup

Supply voltage monitoring

Measuring range	0 V to 36 V DC Max. continuous operating voltage: 36 V DC
Resolution	0.1 V
Accuracy	±0.35 V

D+

Excitation current	210 mA, 12 V 105 mA, 24 V
Charging fail threshold	6 V

Tacho input

Voltage input range	+/- 1 V _{peak} to 70 V _{peak}
W	8 to 36 V
Frequency input range	10 to 10 kHz (max.)
Frequency measurement tolerance	1 % of reading

Digital inputs

Number of inputs	12 x digital inputs Negative switching
Maximum input voltage	+36 V DC with respect to plant supply negative
Minimum input voltage	-24 V DC with respect to plant supply negative
Current source (contact cleaning)	Initial 10 mA, continuous 2 mA

DC outputs

Number of 3 A outputs	2 x outputs (for fuel and crank) 15 A DC inrush and 3 A continuous, supply voltage 0 to 36 V DC Endurance tested according to UL/ULC6200:2019 1.ed: 24 V, 3 A, 100000 cycles (with an external freewheeling diode)
Number of 0.5 A outputs	10 x outputs

DC outputs

	2 A DC inrush and 0.5 A continuous, supply voltage 4.5 to 36 V DC
Common	12/24 V DC

Analogue inputs

Number of inputs	4 x analogue inputs
Electrical range	Configurable as: <ul style="list-style-type: none">• Negative switching digital input• 0 V to 10 V sensor• 4 mA to 20 mA sensor• 0 Ω to 2.5 kΩ sensor
Accuracy	Current: <ul style="list-style-type: none">• Accuracy: $\pm 20 \mu\text{A} \pm 1.00\%$ rdg Voltage: <ul style="list-style-type: none">• Range: 0 to 10 V DC• Accuracy: $\pm 20 \text{ mV} \pm 1.00\%$ rdg RMI 2-wire LOW: <ul style="list-style-type: none">• Range: 0 to 800 Ω• Accuracy: $\pm 2 \Omega \pm 1.00\%$ rdg RMI 2-wire HIGH: <ul style="list-style-type: none">• Range: 0 to 2500 Ω• Accuracy: $\pm 5 \Omega \pm 1.00\%$ rdg

Analogue output

Output types	Isolated DC voltage output
Voltage range	-10 to +10 V DC
Resolution in voltage mode	Better than 1 mV
Max Common Mode Voltage	$\pm 3 \text{ kV}$
Minimum load in voltage mode	500 Ω
Accuracy	$\pm 1\%$ of setting value

Speed governor output

Output types	Isolated DC voltage output Isolated PWM output
Voltage range	-10 to +10 V DC
Resolution in voltage mode	Less than 1 mV
Max Common Mode Voltage	$\pm 550 \text{ V}$
Minimum load in voltage mode	500 Ω
PWM frequency range	1 to 2500 Hz $\pm 25 \text{ Hz}$
PWM duty cycle resolution (0-100%)	12 bits (4096 steps)
PWM voltage range	1 to 10.5 V
Voltage accuracy	$\pm 1\%$ of setting value

Display unit	
Type	Graphical display screen (monochrome)
Resolution	240 x 128 pixels
Navigation	Five-key menu navigation
Log book	Data log and trending function
Language	Multi-language display

3.2 Environmental specifications

Operation conditions	
Operating temperature (incl. display screen)	-40 to +70 °C (-40 to +158 °F)
Storage temperature (incl. display screen)	-40 to +85 °C (-40 to +185 °F)
Accuracy and temperature	Temperature coefficient: 0.2 % of full scale per 10 °C
Operating altitude	0 to 4000 meter with derating
Operating humidity	Damp Heat Cyclic, 20/55 °C at 97 % relative humidity, 144 hours. To IEC 60255-1 Damp Heat Steady State, 40 °C at 93 % relative humidity, 240 hours. To IEC 60255-1
Change of temperature	70 to -40 °C, 1 °C / minute, 5 cycles. To IEC 60255-1
Protection degree	IEC/EN 60529 <ul style="list-style-type: none"> IP65 (front of module when installed into the control panel with the supplied sealing gasket) IP20 on terminal side
Vibration	Response: <ul style="list-style-type: none"> 10 to 58.1 Hz, 0.15 mmpp 58.1 to 150 Hz, 1 g. To IEC 60255-21-1 (Class 2) Endurance: <ul style="list-style-type: none"> 10 to 150 Hz, 2 g. To IEC 60255-21-1 (Class 2) Seismic vibration: <ul style="list-style-type: none"> 3 to 8.15 Hz, 15 mmpp 8.15 to 35 Hz, 2 g. To IEC 60255-21-3 (Class 2)
Shock	10 g, 11 ms, half sine. To IEC 60255-21-2 Response (Class 2) 30 g, 11 ms, half sine. To IEC 60255-21-2 Withstand (Class 2) 50 g, 11 ms, half sine. To IEC 60068-2-27, test Ea Tested with three impacts in each direction in three axes (total of 18 impacts per test)
Bump	20 g, 16 ms, half sine IEC 60255-21-2 (Class 2) Tested with 1000 impacts in each direction on three axes (total of 6000 impacts per test)
Galvanic separation	CAN port 2: 550 V, 50 Hz, 1 minute RS-485 port 1: 550 V, 50 Hz, 1 minute Ethernet: 550 V, 50 Hz, 1 minute Analogue output 51-52 (GOV): 550 V, 50 Hz, 1 minute Analogue output 54-55 (AVR): 3000 V, 50 Hz, 1 minute Note: No galvanic separation on CAN port 1 and RS-485 port 2
Safety	Installation CAT. III 600 V Pollution degree 2 IEC/EN 60255-27
Flammability	All plastic parts are self-extinguishing to UL94-V0
EMC	IEC/EN 60255-26

3.3 UL/cUL Listed

Requirements	
Installation	To be installed in accordance with the NEC (US) or the CEC (Canada)
Enclosure	A suitable type 1 (flat surface) enclosure is required Unventilated/ventilated with filters for controlled/pollution degree 2 environment
Mounting	Flat surface mounting
Connections	Use 90 °C copper conductors only
Wire size	AWG 30-12
Terminals	Tightening torque: 5-7 lb-in.
Current transformers	Use Listed or Recognized isolating current transformers
Communication circuits	Only connect to communication circuits of a listed system/equipment

3.4 Communication

Communication	
CAN A	<p>Used for:</p> <ul style="list-style-type: none"> • Engine CAN Port • CIO 116, CIO 208 and CIO 308 • IOM 220 and IOM 230 <p>Data connection 2 wire + common Not isolated External termination required (120 Ω + matching cable) DEIF engine specification (J1939 + CANopen)</p>
CAN B	<p>Used for:</p> <ul style="list-style-type: none"> • AOP-2 <p>Data connection 2 wire + common Isolated External termination required (120 Ω + matching cable) PMS 125 kbit and 250 kbit</p>
RS-485 Port 1	<p>Used for: Modbus RTU, PLC, SCADA Data connection 2-wire + common Isolated External termination required (120 Ω + matching cable) 9600 to 115200</p>
RS-485 Port 2	<p>Used for: Modbus RTU, PLC, SCADA Data connection 2-wire + common Not isolated External termination required (120 Ω + matching cable) 9600 to 115200</p>
RJ45 Ethernet	<p>Used for:</p> <ul style="list-style-type: none"> • Modbus to PLC, SCADA and so on • NTP time synchronisation with NTP servers <p>Isolated Auto detecting 10/100 Mbit Ethernet port</p>
USB	Service port (USB-B)

3.5 Approvals

Standards

CE

UL/cUL Listed to UL/ULC6200:2019, 1. ed. controls for stationary engine gensets

NOTE Refer to www.deif.com for the most recent approvals.

3.6 Dimensions and weight

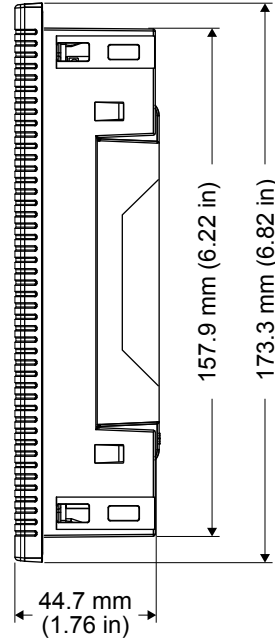
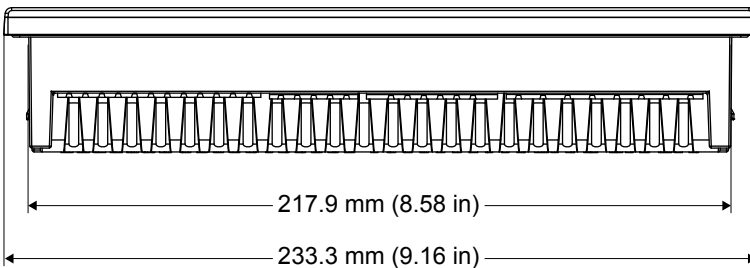
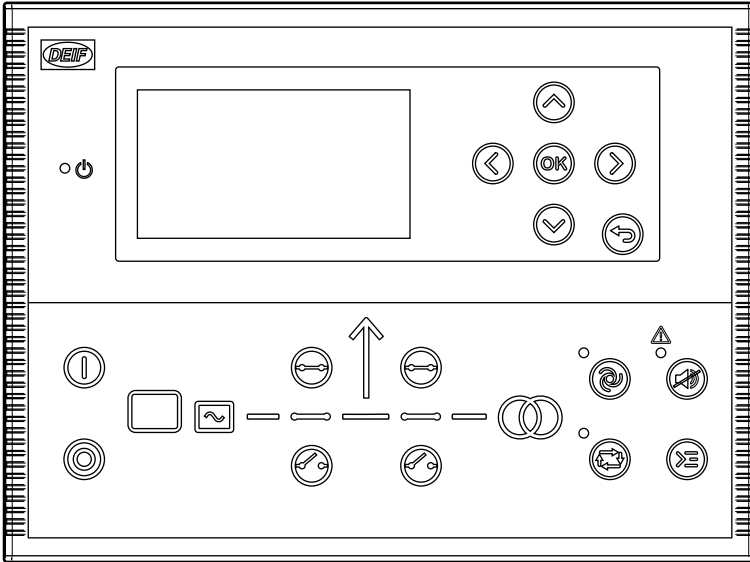

Dimensions and weight

Dimensions	Length: 233.3 mm (9.16 in) Height: 173.3 mm (6.82 in) Depth: 44.7 mm (1.76 in)
Panel cutout	Length: 218.5 mm (8.60 in) Height: 158.5 mm (6.24 in) Tolerance: ± 0.3 mm (0.01 in)
Max. panel thickness	4.5 mm (0.18 in)
Mounting	UL/cUL Listed: Type complete device, open type 1 UL/cUL Listed: For use on a flat surface of a type 1 enclosure
Weight	0.79 kg

4. Legal information

4.1 Disclaimer

DEIF A/S reserves the right to change any of the contents of this document without prior notice.

The English version of this document always contains the most recent and up-to-date information about the product. DEIF does not take responsibility for the accuracy of translations, and translations might not be updated at the same time as the English document. If there is a discrepancy, the English version prevails.

4.2 Copyright

© Copyright DEIF A/S. All rights reserved.

4.3 Software version

This document is based on the AGC 150 software version 1.14.